

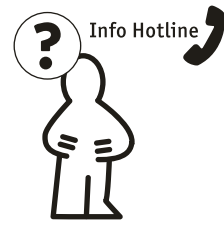

# Safety Instructions



0,1,2,4,6,7,8,11,15,  
18,19,25,26,28



Info Hotline **+49 (0) 5041 998 389**  
Mon. - Do. 7<sup>00</sup> - 20<sup>00</sup>  
Fr. 7<sup>00</sup> - 17<sup>00</sup>

Paulmann Licht GmbH  
31832 Springe / Germany  
www.paulmann.com

Art.-Nr.:  
927.54...927.80  
938.17...938.20  
927.21 927.22

(+MA 173)  
PH 10/15 

927.64  
927.67  
927.69  
927.77  
927.79

927.65 927.75  
927.66 927.76  
927.68 927.78  
927.70 927.80

938.17  
938.19

938.18  
938.20

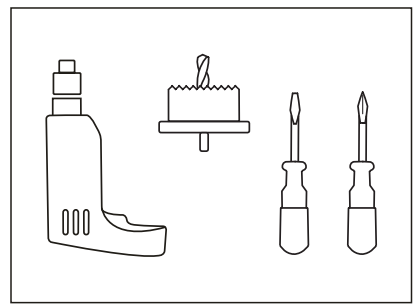

927.72

927.71  
927.73  
927.74

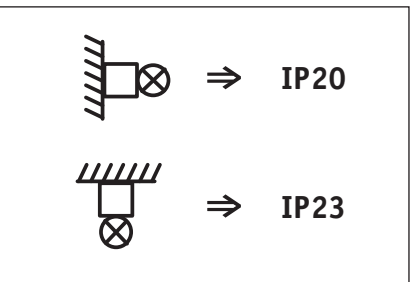
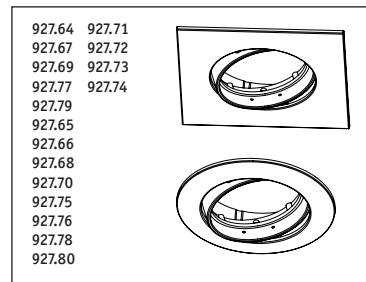

927.54  
927.56  
927.58

927.55  
927.57  
927.59  
927.21  
927.22

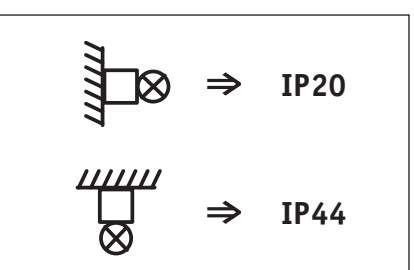
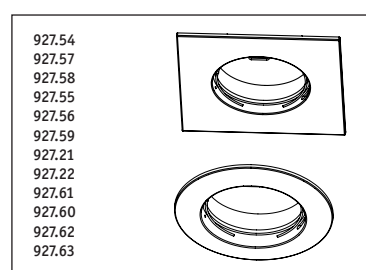

927.61

927.60  
927.62  
927.63

