



P



Paulmann



MaxLED Strips e profili

Pianificazione e consulenza – sistema componenti 24 V





Luce più gradevole per ambienti comfort

MaxLED Strips LED

Trasformano gli ambienti in luoghi del cuore

Con le Strips LED di Paulmann immergerai ogni ambiente nella giusta luce, diretta o indiretta.

Tutto da un unico fornitore: Con le Strips LED flessibili, autoadesive e i profili Paulmann abbinati puoi realizzare le tue idee illuminotecniche.

Le **Strips MaxLED 250** emanano **una luce decorativa** e faranno fluttuare i tuoi mobili. Fanno risplendere le pareti, trasformeranno il bagno in una piccola oasi o ti daranno sicurezza illuminando le scale.

Le **Strips MaxLED 500** luminose illuminano la tua postazione in cucina, la tua officina o altre superfici di lavoro. Garantiscono una **perfetta luminosità per lavorare** senza abbagliare.

Le **Strips MaxLED 1000** molto luminose emettono una luce adeguata per un'illuminazione completa dell'ambiente. **Illuminano gli ambienti abitativi** e creano un'illuminazione generale confortevole in modalità di regolazione dell'intensità.

Le Strips potenti della serie **MaxLED Full-Line COB** generano una **luce assolutamente omogenea senza punti luce visibili**.

Con i **versatili accessori** puoi gestire la luminosità e i colori della luce delle tue Strips MaxLED tramite telecomando, comando vocale, app o sensore. In questo modo avrai la luce perfetta in tutti i tuoi ambienti.



Il tuo progetto, il tuo tocco speciale

I progetti fai da te da imitare sono disponibili su YouTube



www.youtube.com/PaulmannLicht



Le Strips MaxLED in sintesi

1 Come rilevo la luminosità?

Per ciascuno scopo di utilizzo, dalla luce decorativa alla luce d'ambiente intensa, garantiamo la perfetta luminosità. Dall'indicazione dei Lumen (lm) o Lumen per metro (lm/m) puoi scoprire il grado di luminosità di una Strip LED.

Per fare un confronto: Una lampadina a incandescenza da 40 Watt aveva una luminosità totale di 400 Lumen. Una Strip MaxLED 500 ha una luminosità di 550 Lumen.

2 Quando è appropriato utilizzare un rivestimento?

- Le **Strips non rivestite** sono più adatte per mobili e profili laddove vengono collocate in posizione protetta.
- Le **Strips rivestite con Protective Cover** sono più resistenti durante il montaggio e l'uso, pertanto possono essere liberamente installate sui mobili. Lo stato trasparente le protegge dalla polvere e dallo sporco, e quindi possono essere installate liberamente nell'ambiente, ad es. su mobili e complementi d'arredo.
- Con una protezione aggiuntiva per i punti di contatto, le Strips sono anche protette contro gli spruzzi d'acqua (IP44) e adatte quindi all'uso in cucina e in bagno.
- Le Strips MaxLED Full-Line COB sono protette dalla polvere grazie a uno strato protettivo dei LED



3 Quale colore della luce scegliere?

Analogamente alla luce del sole, anche la temperatura di colore dei LED influenza la nostra salute. La temperatura di colore viene indicata in Kelvin (K) e rivela se un LED emette una luce giallo-calda (2700 K) o una luce blu-fredda (6500 K).

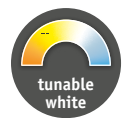

Tunable White offre una selezione tra le tonalità della luce bianca che spaziano dal bianco caldo per il relax, bianco neutro energizzante al bianco naturale per attività che richiedono concentrazione.



Con **RGBW** puoi scegliere tra 16 milioni di tonalità di colore e anche la funzione Tunable-White.

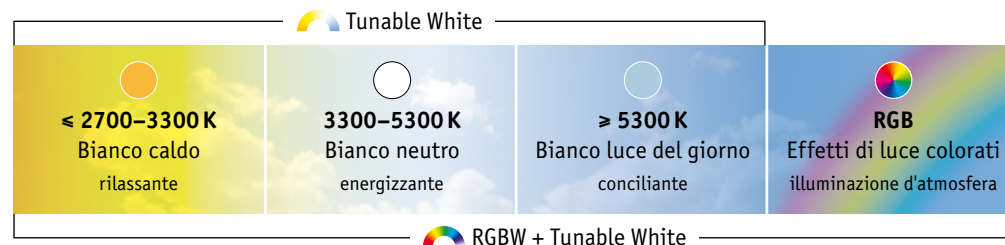

Le Strips MaxLED in sintesi

| | MaxLED 250 24 V = 8 | MaxLED 500 24 V = 12 | MaxLED 500 Full-Line COB 24 V = 18 | MaxLED 1000 24 V = 13 | MaxLED 1000 Full-Line COB 24 V = 19 |
|--|--|--|---|--|---|
| Applicazione della luce | Luce decorativa | Luce di lavoro | Luce di lavoro | Luce d'ambiente | Luce d'ambiente |
| Luminosità in Lumen per metro (in base al colore della luce) | 300 lm/m | 550 lm/m | 500 lm/m | 1100 lm/m | 1000 lm/m |
| Numero LED per metro (in base al colore della luce) | 30 LED/m | 64 LEDs/m (Strips non rivestite) 72 LEDs/m (Strips rivestite) | 640 LED/m | 128 LEDs/m (Strips non rivestite) 144 LEDs/m (Strips rivestite) | 673 LED/m |
| Dimensioni | Lunghezza set: 1–5 m (ampliabile) Larghezza: 12,5 mm Accorciabile: ogni 167 cm | Lunghezza set: 1–10 m (ampliabile) Larghezza: 12,5 mm Accorciabile: ogni 125 mm (Strips non rivestite) ogni 83 mm (Strips rivestite) | Lunghezza set: 1,5–3 m (ampliabile) Larghezza: 10 mm Accorciabile: ogni 50 mm | Lunghezza set: 1–3 m (ampliabile) Larghezza: 12,5 mm Accorciabile: ogni 63 mm (Strips non rivestite) ogni 41,5 mm (Strips rivestite) | Lunghezza set: 1,5–3 m (ampliabile) Larghezza: 10 mm Accorciabile: ogni 50 mm |
| Strips non rivestite (IP20) | ✓ | ✓ | | ✓ | |
| Strips rivestite (Protective Cover – IP44) | ✓ | ✓ | | ✓ | |
| Con strato protettivo dei LED | | | ✓ | | ✓ |
| Colore della luce | 2700 K 6500 K Tunable White RGBW + Tunable White | 2700 K 4000 K 2700 K 6500 K Tunable White RGBW + Tunable White | 2700 K 6500 K Tunable White RGBW + Tunable White | 2700 K 4000 K 2700 K 6500 K Tunable White RGBW + Tunable White | 2700 K 6500 K Tunable White RGBW + Tunable White |

Comfort Set MaxLED

Pratici set completi con Strip, alimentazione e modulo di comando



MaxLED 250 Comfort Set TV



- Illuminazione di sfondo per il televisore su quattro lati per un ambiente e una retroilluminazione omogenei
- Ideale per televisori sospesi
- Commutabile indipendentemente dalla TV
- Dimmerabile
- Incl. 4x connettori angolari
- Autoadesivo sul retro per un facile montaggio
- Upgrade intelligente: Controller Zigbee compatibile

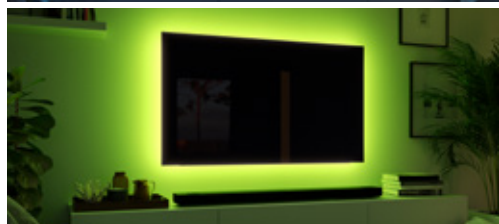

Comfort Set TV 55"
20,5 W, 916 lm
24 VA, ⇄3616 mm

78875

Comfort Set TV 65"
22 W, 1000 lm
24 VA, ⇄4282 mm

78876



MaxLED 250 Comfort Set 1 m



- Interruttore touch discreto incluso
- Ideale per scaffali aperti
- Dimmerabile
- Strips LED di 1 m da tagliare e ricollegare
- Agevole sistema a innesto
- Autoadesivo sul retro per un facile montaggio



MaxLED 250 Comfort Set 1 m
4 W, 300 lm
12 VA, ⇄max. 2 m

78895



MaxLED 250 Comfort Set Night



- Rilevatore di movimento incluso: viene attivato al crepuscolo dal movimento (raggio 4,5 m)
- Durata dell'illuminazione regolabile individualmente: <30 secondi – 6 minuti
- Agevole sistema a innesto
- Autoadesivo sul retro per un facile montaggio

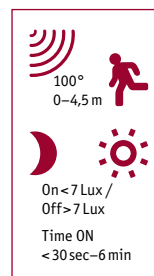

Comfort Set Night 1 m

78893

4 W, 300 lm
12 VA, ⇄max. 2 m

Comfort Set Night 2x 1 m

78894

2x 4 W, 2x 300 lm
24 VA, ⇄max. 4 m



MaxLED 500 Comfort Set Kitchen



- Soluzione comfort per l'illuminazione di sottopensili
- Adatto per tutte le misure di cucina standard – per elementi da 40, 50 o 60
- Comprende Strips combinabili e accorciabili con rivestimento: 3x 10 cm / 3x 50 cm
- Incl. interruttore touch per regolazione intensità e commutazione
- Incl. cavi per superare le distanze (ad es. cappa)



Comfort Set Kitchen

79838

3x 10 cm/3x 50 cm
11 W, 960 lm
20 VA, ⇄max. 2,8 m

MaxLED 250

Set di base estensibili (incluso trasformatore) e Strips di estensione



Strips non rivestite



Warm White

Tunable White

RGBW + TunW

Basic Set



| | | | | | | |
|-------|--|--------------|--|--------------|--|--------------|
| 1,5 m | 12 W, 900 lm 24 VA, $\leftarrow_{max.} \rightarrow$ 5,5 m | 79852 | 11 W, 810 lm 24 VA, $\leftarrow_{max.} \rightarrow$ 6 m | 79860 | 20 W, 810 lm 36 VA, $\leftarrow_{max.} \rightarrow$ 5 m | 79864 |
|-------|--|--------------|--|--------------|--|--------------|

Strip



| | | | | | | |
|-------|---------------|--------------|-----------------|--------------|---------------|--------------|
| 1 m | 4 W, 300 lm | 79853 | 3,5 W, 270 lm | 79861 | 6,5 W, 270 lm | 79865 |
| 2,5 m | 10 W, 750 lm | 79854 | 8,8 W, 675 lm | 79862 | 16 W, 675 lm | 79866 |
| 5 m | 20 W, 1500 lm | 79855 | 17,5 W, 1350 lm | 79863 | 30 W, 1350 lm | 79867 |

Strips rivestite (Protective Cover)



Warm White

Tunable White

RGBW + TunW

Basic Set



| | | | | | | |
|-------|---|--------------|--|--------------|--|--------------|
| 1,5 m | 6 W, 450 lm 24 VA, $\leftarrow_{max.} \rightarrow$ 5,5 m | 79868 | 5,5 W, 405 lm 7,2 VA, $\leftarrow_{max.} \rightarrow$ 6 m | 79876 | 10 W, 405 lm 24 VA, $\leftarrow_{max.} \rightarrow$ 3 m | 79880 |
|-------|---|--------------|--|--------------|--|--------------|

| | | | | | | |
|-----|--|--------------|--|--------------|--|--------------|
| 3 m | 12 W, 900 lm 24 VA, $\leftarrow_{max.} \rightarrow$ 5,5 m | 79869 | 11 W, 810 lm 24 VA, $\leftarrow_{max.} \rightarrow$ 6 m | 79877 | 20 W, 810 lm 36 VA, $\leftarrow_{max.} \rightarrow$ 5 m | 79881 |
|-----|--|--------------|--|--------------|--|--------------|

Strip



| | | | | | | |
|-------|--------------|--------------|-------------|--------------|--------------|--------------|
| 2,5 m | 10 W, 750 lm | 79871 | 9 W, 675 lm | 79879 | 17 W, 675 lm | 79883 |
|-------|--------------|--------------|-------------|--------------|--------------|--------------|



Esempi di progetti per le tue Strips LED sono disponibili alle pagine 28–29.

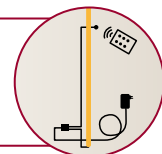

MaxLED 500

Set di base potenti, estensibili
(incluso trasformatore) e Strips di estensione



Strips rivestite (Protective Cover)

| | Warm White | Daylight | Tunable White | RGBW + TunW |
|------------------|--------------------------------|--------------------------------|--------------------------------|--------------------------------|
| Basic Set | | | | |
| 1,5 m | 9W, 825lm 20 VA, max. 3 m | 9W, 825lm 20 VA, max. 3 m | 10W, 825lm 20 VA, max. 3 m | 18W, 750lm 36 VA, max. 3 m |
| 3 m | 18W, 1650lm 36 VA, max. 6 m | 18W, 1650lm 36 VA, max. 6 m | 20W, 1650lm 36 VA, max. 5 m | 36W, 1500lm 60 VA, max. 6 m |
| Strip | | | | |
| 1 m | 6W, 550lm 70663 | 6W, 550lm 70663 | 7W, 550lm 70630 | 12W, 500lm 70634 |
| 2,5 m | 6W, 550lm 70663 | 15W, 1375lm 70548 | | |



MaxLED 1000

Set di base molto potenti, estensibili
(incluso trasformatore) e Strips di estensione



Strips rivestite (Protective Cover)

| | Warm White | Daylight | Tunable White | RGBW + TunW |
|------------------|----------------------------------|----------------------------------|----------------------------------|----------------------------------|
| Basic Set | | | | |
| 1,5 m | 18W, 1650lm 36 VA, max. 3 m | 18W, 1650lm 36 VA, max. 3 m | 17W, 1530lm 36 VA, max. 3 m | 18W, 1500lm 25 VA, max. 4 m |
| 3 m | 35W, 3300lm 60 VA, max. 5,5 m | 35W, 3300lm 60 VA, max. 5,5 m | 32W, 3060lm 60 VA, max. 5,5 m | 33W, 3000lm 75 VA, max. 5,5 m |
| Strip | | | | |
| 1 m | 12W, 1100lm 70676 | 12W, 1100lm 70675 | | |
| 2,5 m | 29W, 2750lm 70552 | 29W, 2750lm 70553 | 27W, 2550lm 70533 | 28W, 2500lm 70530 |



MaxLED 500 – Efficient*

Set di base potenti, estensibili
(incluso trasformatore) e Strips di estensione



- Luce di lavoro energeticamente efficiente
- Strips LED con classe di efficienza energetica D
- Stessa potenza con un consumo energetico inferiore del 40 % rispetto alle Strips convenzionali*
- Senza rivestimento (IP20) e ideali per l'impiego in profili
- Accorciabili in modo personalizzato

*MaxLED 500: 3,6 W / metro vs articolo vecchio = 6 W / metro

| Strips non rivestite | | | |
|----------------------|-----------------------------------|-----------------------------------|---------------|
| | Warm White | Neutral White | |
| Basic Set | | | |
| 1,5 m | 5,5 W, 825 lm 20 VA, max. 5 m | 5,5 W, 825 lm 20 VA, max. 5 m | 71232 / 71238 |
| 3 m | 11 W, 1650 lm 30 VA, max. 10 m | 11 W, 1650 lm 30 VA, max. 10 m | 71231 / 71237 |
| 5 m | 17 W, 2750 lm 30 VA, max. 10 m | 17 W, 2750 lm 30 VA, max. 10 m | 71230 / 71236 |
| 10 m | 28 W, 5500 lm 40 VA, max. 20 m | 28 W, 5500 lm 40 VA, max. 20 m | 71229 / 71235 |
| Strip | | | |
| 1 m | 3,6 W, 550 lm | 3,6 W, 550 lm | 71234 / 71240 |
| 2,5 m | 9 W, 1375 lm | 9 W, 1375 lm | 71233 / 71239 |

MaxLED 1000 – Efficient**

Set di base potenti, estensibili
(incluso trasformatore) e Strips di estensione



- Illuminazione degli spazi abitativi energeticamente efficiente
- Strips LED con classe di efficienza energetica D
- Stessa potenza con un consumo energetico inferiore del 40 % rispetto alle Strips convenzionali**
- Senza rivestimento (IP20) e ideali per l'impiego in profili
- Accorciabili in modo personalizzato

**MaxLED 1000: 7,2 W / metro vs articolo vecchio = 12 W / metro

| Strips non rivestite | | | |
|----------------------|-----------------------------------|-----------------------------------|---------------|
| | Warm White | Neutral White | |
| Basic Set | | | |
| 1,5 m | 11 W, 1650 lm 30 VA, max. 5 m | 11 W, 1650 lm 30 VA, max. 5 m | 71243 / 71248 |
| 3 m | 22 W, 3300 lm 40 VA, max. 8 m | 22 W, 3300 lm 40 VA, max. 8 m | 71242 / 71247 |
| 5 m | 30 W, 5500 lm 60 VA, max. 10 m | 30 W, 5500 lm 60 VA, max. 10 m | 71241 / 71246 |
| Strip | | | |
| 1 m | 7,2 W, 1100 lm | 7,2 W, 1100 lm | 71245 / 71250 |
| 2,5 m | 18 W, 2750 lm | 18 W, 2750 lm | 71244 / 71249 |

Più che una luce smart

Sistemi di comando smart per le tue Strips



www.paulmann.com/zb

Lo standard radio Zigbee ti permette di gestire i prodotti tramite comando vocale e controllarli in tutta l'abitazione: anche con accesso remoto.

Per comandare i componenti Zigbee è necessario un Gateway Zigbee 3.0, ad esempio Amazon Echo o Philips Hue Bridge (ad eccezione di: Hue Entertainment).

Per comandare in modo intelligente le tue Strips LED basta selezionare il Controller idoneo. Il Controller viene inserito senza attrezzi tra il trasformatore e la Strip LED: non serve fare altro.

max. 144 W
DC 24 V



Switch/Dimm Controller **50045**



Tunable White Controller **50046**



RGBW + TunW Controller **50047**

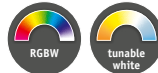

Comando di uno o più Controller

Selezione diretta di colori e tonalità di bianco

Gent 2 Smart Remote Control **50140**



Gestione diretta fino a 30 dispositivi

Possibilità di memorizzare due preset individuali

Basic Remote Control **50141**

MaxLED 250 & 500 – Set intelligenti

Set base estensibili (incluso trasformatore)



- MaxLED 250 come illuminazione decorativa e MaxLED 500 come luce di lavoro ideale
- Eccellente esperienza dell'utente con un elevato comfort giorno dopo giorno
- Controller Zigbee incluso
- Elevata compatibilità con il sistema: Interfaccia Zigbee da integrare in altre soluzioni Smart Home
- Tutti i set MaxLED 250 possono essere ampliati con le Strips singole a pagina 8. Le Strips di estensione MaxLED 500 sono riportate a pagina 10.



Ready for

- Paulmann smik Gateway
- Philips Hue Bridge 2 (a eccezione di: Hue Entertainment)
- Amazon Echo Smart Speaker con interfaccia Zigbee
- Telecomandi Paulmann: Gent 2 e Basic

Controllo vocale e con app con Zigbee 3.0 Gateway

Comando diretto

Strips rivestite (Protective Cover)

| | Tunable White | RGBW + TunW | Tunable White | RGBW + TunW |
|-----------|---|---|---|---|
| Basic Set | | | | |
| 3 m | 17 W, 1530 lm 36 VA, $\leftarrow_{max.} \rightarrow$ 6 m | 27 W, 1200 lm 60 VA, $\leftarrow_{max.} \rightarrow$ 6 m | 12 W, 810 lm 36 VA, $\leftarrow_{max.} \rightarrow$ 8 m | 15 W, 600 lm 36 VA, $\leftarrow_{max.} \rightarrow$ 8 m |
| 5 m | 26 W, 2750 lm 50 VA, $\leftarrow_{max.} \rightarrow$ 8 m | 33 W, 2000 lm 80 VA, $\leftarrow_{max.} \rightarrow$ 8 m | 18 W, 1350 lm 36 VA, $\leftarrow_{max.} \rightarrow$ 8 m | 22 W, 1000 lm 36 VA, $\leftarrow_{max.} \rightarrow$ 8 m |

MaxLED 500 e 1000 Full-Line COB

Una linea di luce omogenea e lineare senza punti luce visibili



Innovativa tecnologia COB



Tecnologia a LED comune

- L'innovativa tecnica COB genera una diffusione della luce lineare senza punti luce singoli
- MaxLED 500 come luce di lavoro omogenea
- MaxLED 1000 come illuminazione ambientale potente
- Ampio angolo emissione di 180°
- Connettore a tutti i componenti degli accessori e di comando MaxLED tramite il connettore a 5 pin
- Edge: continua una diffusione della luce attorno a un angolo di 90° senza spazi vuoti
- Collegamento e ampliamento perfetto tramite connettori intelligenti
- Robusto e lavabile
- Lo strato protettivo continuo sopra i LED completi protegge dalla polvere
- Larghezza di soli 10 mm – perfetto per profili LED filigranati



MaxLED Full-Line COB – Connector Set

- Incl. 2x adattatori a 5 pin da 10 cm, per inserire i sistemi di comando e i componenti MaxLED
- Incl. 2x connettori per un ampliamento continuo
- Incl. 2x adattatori da COB a COB 10 cm
- Adatto per MaxLED 500 Full-Line COB e MaxLED 1000 Full-Line COB



only for MaxLED COB Strips ● 2700 K ● 6500 K

MaxLED Full-Line COB Connector Set **71051**

only for MaxLED COB Strips ● tunable white

MaxLED Full-Line COB Connector Set **71057**

only for MaxLED COB Strips ● RGBW

MaxLED Full-Line COB Connector Set **71058**

MaxLED 500 Full-Line COB

Ideale come luce di lavoro omogenea e uniforme



Con strato protettivo dei LED

| | Warm White | Daylight | Tunable White | RGBW + TunW |
|------------------|---|---|---|---|
| Basic Set | | | | |
| 1,5 m | 10 W, 750 lm 71045 25 VA, $\leftarrow_{\text{max.}}$ 4 m | 10 W, 900 lm 71123 25 VA, $\leftarrow_{\text{max.}}$ 4 m | 10 W, 900 lm 71110 25 VA, $\leftarrow_{\text{max.}}$ 4 m | 10 W, 795 lm 71197 24 VA, $\leftarrow_{\text{max.}}$ 4 m |
| 3 m | 19 W, 1500 lm 71046 36 VA, $\leftarrow_{\text{max.}}$ 5,5 m | 19 W, 1800 lm 71124 36 VA, $\leftarrow_{\text{max.}}$ 5,5 m | 15 W, 1800 lm 71111 36 VA, $\leftarrow_{\text{max.}}$ 5,5 m | 18 W, 1590 lm 71198 36 VA, $\leftarrow_{\text{max.}}$ 5,5 m |
| Strip | | | | |
| 2,5 m | 15 W, 1250 lm 71047 | 15 W, 1500 lm 71125 | 13 W, 1500 lm 71112 | 15 W, 1325 lm 71199 |
| Edge | | | | |
| | 0,3 W, 25 lm 71121 | 0,3 W, 30 lm 71126 | 0,35 W, 30 lm 71113 | max. 144 W, 24 V 71203 |

MaxLED 1000 Full-Line COB

Ideale come luce ambientale potente e omogenea



Con strato protettivo dei LED

| | Warm White | Daylight | Tunable White | RGBW + TunW |
|------------------|---|---|---|---|
| Basic Set | | | | |
| 1,5 m | 18 W, 1620 lm 71048 25 VA, $\leftarrow_{\text{max.}}$ 4 m | 18 W, 1920 lm 71127 40 VA, $\leftarrow_{\text{max.}}$ 5,5 m | 15,5 W, 1800 lm 71114 40 VA, $\leftarrow_{\text{max.}}$ 4 m | 17 W, 1557 lm 71200 48 VA, $\leftarrow_{\text{max.}}$ 4 m |
| 3 m | 36 W, 3240 lm 71049 50 VA, $\leftarrow_{\text{max.}}$ 5,5 m | 36 W, 3840 lm 71128 50 VA, $\leftarrow_{\text{max.}}$ 5,5 m | 25,5 W, 3600 lm 71115 50 VA, $\leftarrow_{\text{max.}}$ 5,5 m | 27 W, 3114 lm 71201 60 VA, $\leftarrow_{\text{max.}}$ 5,5 m |
| Strip | | | | |
| 2,5 m | 30 W, 2700 lm 71050 | 30 W, 3200 lm 71129 | 23,5 W, 3000 lm 71116 | 24 W, 2595 lm 71202 |
| Edge | | | | |
| | 0,6 W, 54 lm 71122 | 0,6 W, 64 lm 71130 | 0,65 W, 60 lm 71117 | max. 144 W, 24 V 71203 |

Trasformatori

Per i tuoi progetti personalizzati



Power Supply 12 W 79835
max. 12 W
230/24 V, 12 VA
⌀26 ⇄63 ⌀40 mm



Power Supply 36 W 79837
max. 36 W
230/24 V, 36 VA
⌀31 ⇄101 ⌀51 mm



Power Supply 40 W 79831
max. 40 W
230/24 V, 40 VA
⌀24 ⇄166 ⌀52 mm



Power Supply 60 W 79830
max. 60 W
230/24 V, 60 VA
⌀32 ⇄184 ⌀61 mm



Power Supply 150 W 70976
max. 150 W
230/24 V, 150 VA
⌀34 ⇄210 ⌀67 mm

| Puoi creare le lunghezze totali con i nostri trasformatori | 12 W | | 36 W | | 40 W | | 60 W | | 150 W | |
|--|-------|------------------------|-------|------------------------|-------|------------------------|------|------------------------|-------|-----------------------|
| | → | ↔ | → | ↔ | → | ↔ | → | ↔ | → | ↔ |
| MaxLED 500 Efficient* Warm White, Neutral White | 3 m | 3 m (1,5 m + 1,5 m) | 10 m | 10 m (5 m + 5 m) | 10 m | 10 m (5 m + 5 m) | 20 m | 20 m (10 m + 10 m) | 20 m | 40 m (20 m + 20 m) |
| MaxLED 1000 Efficient** Warm White, Neutral White | 1,5 m | 1,5 m | 5 m | 5 m (2,5 m + 2,5 m) | 5 m | 5 m (2,5 m + 2,5 m) | 10 m | 10 m (5 m + 5 m) | 10 m | 20 m (10 m + 10 m) |
| MaxLED 250 Warm White, Daylight, Tunable White | 3 m | 3 m (1,5 m + 1,5 m) | 10 m | 9 m (4,5 m + 4,5 m) | 11 m | 10 m (5 m + 5 m) | 17 m | 16 m (8 m + 8 m) | 30 m | 40 m (20 m + 20 m) |
| MaxLED 250 RGBW | 1,5 m | 1 m (0,5 m + 0,5 m) | 5,5 m | 5 m (2,5 m + 2,5 m) | 6,5 m | 6 m (3 m + 3 m) | 10 m | 9 m (4,5 m + 4,5 m) | 20 m | 22 m (11 m + 11 m) |
| MaxLED 500 Warm White, Daylight | 2 m | 2 m (1 m + 1 m) | 6 m | 6 m (3 m + 3 m) | 6,5 m | 6 m (3 m + 3 m) | 12 m | 10 m (5 m + 5 m) | 20 m | 22 m (11 m + 11 m) |
| MaxLED 500 RGBW | 1 m | 1 m (0,5 m + 0,5 m) | 3 m | 3 m (1,5 m + 1,5 m) | 3,5 m | 3 m (1,5 m + 1,5 m) | 6 m | 5 m (2,5 m + 2,5 m) | 10 m | 16 m (8 m + 8 m) |
| MaxLED 500 Tunable White | 1,5 m | 1 m (0,5 m + 0,5 m) | 5 m | 5 m (2,5 m + 2,5 m) | 6,5 m | 6 m (3 m + 3 m) | 10 m | 9 m (4,5 m + 4,5 m) | 20 m | 22 m (11 m + 11 m) |
| MaxLED 500 COB Warm White, Daylight, RGBW | 2 m | 2 m (1 m + 1 m) | 6 m | 6 m (3 m + 3 m) | 6,5 m | 6 m (3 m + 3 m) | 12 m | 10 m (5 m + 5 m) | 20 m | 22 m (11 m + 11 m) |
| MaxLED 1000 Warm White, Daylight | 1 m | 1 m (0,5 m + 0,5 m) | 3 m | 2 m (1 m + 1 m) | 3 m | 2 m (1 m + 1 m) | 5 m | 4 m (2 m + 2 m) | 10 m | 12 m (6 m + 6 m) |
| MaxLED 1000 RGBW | 1 m | 1 m (0,5 m + 0,5 m) | 3 m | 2 m (1 m + 1 m) | 3 m | 2 m (1 m + 1 m) | 5 m | 4 m (2 m + 2 m) | 10 m | 12 m (6 m + 6 m) |
| MaxLED 1000 Tunable White | 1 m | 1 m (0,5 m + 0,5 m) | 3 m | 2 m (1 m + 1 m) | 3 m | 2 m (1 m + 1 m) | 5 m | 4 m (2 m + 2 m) | 10 m | 12 m (6 m + 6 m) |
| MaxLED 1000 COB Warm White, Daylight, Tunable White, RGBW | 1 m | 1 m (0,5 m + 0,5 m) | 3 m | 2 m (1 m + 1 m) | 3 m | 2 m (1 m + 1 m) | 5 m | 4 m (2 m + 2 m) | 10 m | 12 m (6 m + 6 m) |

→ Lunghezza massima se inserisci le Strips in successione diretta.

↔ Lunghezza massima se suddividi le Strips in due linee, per fare questo puoi utilizzare ad es. lo Y-Splitter. I valori tra parentesi indicano la lunghezza massima delle singole linee. Con ulteriori diramazioni, la lunghezza totale si riduce. Per calcolare la misura del trasformatore, basta sommare le singole potenze (W) delle Strips.

*MaxLED 500: 3,6 W / metro vs articolo vecchio = 6 W / metro

**MaxLED 1000: 7,2 W / metro vs articolo vecchio = 12 W / metro

Connettore per tutte le Strips MaxLED



Flex-Connector 10 cm **70576**

Flex-Connector 1 m **70575**

Flex-Connector 5 m **70574**

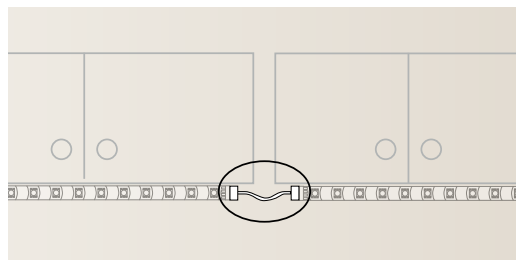

Cavo di collegamento per allungare, bypassare o eseguire pose in spazi ridotti. Pensato anche per installare il trasformatore in posizione invisibile.



Invisible Connector 3 m **79828**



Sopraverniciabile e ultrapiatto per un'installazione invisibile (ad es. alimentazione nascosta dietro mobili o simili e posa di un'alimentazione di corrente invisibile).



Y-Splitter 30 cm **79813**

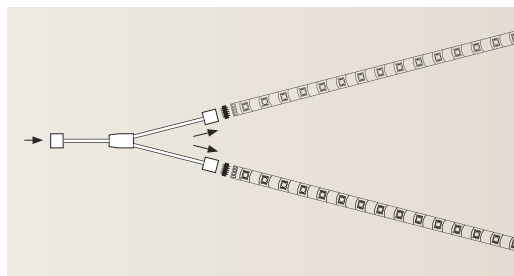

Cavo di collegamento per la semplice suddivisione in due linee.



1x

X-Connector **70617**

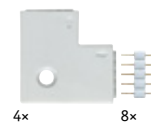

4x

8x

Edge-Connector 90° **70616**



4x

8x

Edge-Connector **70615**



Per angoli o diversi livelli (angoli interni ed esterni).



1x

Clip-to-Clip Connector **70618**



Per ricollegare due Strips da 24 V tagliate, non rivestite.

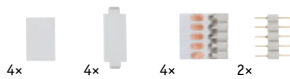

4x

4x

4x

2x

2x

Universal Connector 10 cm **70919**

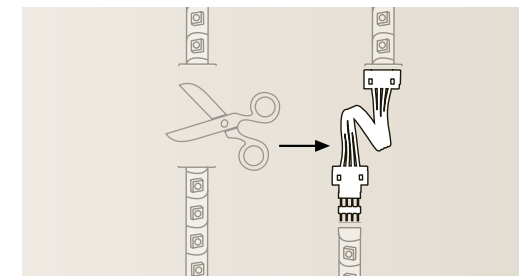

Per ricollegare Strips da 24 V tagliate rivestite e non rivestite con altre Strips da 24 V o per accessori MaxLED quali angoli, Flex Connector, ecc.

Il connettore universale è adatto al Corner Profil.

Interruttore e sistemi di comando per tutte le Strips MaxLED

Interruttore, sensori e controller



Touch Switch **70975**

max. 144 W, DC 24 V
 ⌀8,5 ⇄43 ↗30 mm

Commutazione e regolazione dell'intensità comode con sfioramento



Night PIR Sensor **70974**

max. 144 W, DC 24 V
 ⌀33 ⇄48 ↗35 mm

L'interruttore crepuscolare per il controllo dipendente dalla luce diurna garantisce comfort e sicurezza:



Dimm/Switch Controller IR **70683**

max. 144 W, DC 24 V
 ⌀8,5 ⇄43 ↗30 mm

Commutazione e dimming tramite contatto visivo fra telecomando e ricevitore.



Dimm/Switch-Controller **70619**

max. 144 W, DC 24 V, 2,4 GHz
 ⌀8,5 ⇄43 ↗30 mm

Commutazione e dimming senza contatto visivo fra telecomando e ricevitore (portata 30 m all'aperto).



max. 144 W

MaxLED RGBW Controller **70526**

max. 144 W, DC 24 V
 ⌀22 ⇄50 ↗35 mm

Controller singolo per i colori della luce RGBW / Tunable White.



MaxLED TunW Controller **70527**

max. 144 W, DC 24 V
 ⌀22 ⇄50 ↗35 mm

Controller singolo per i colori della luce Tunable White.

Radio Controller per Strips MaxLED RGBW



max. 144 W

RGBW-Controller 2,4 GHz **79797**

max. 144 W, DC 24 V
 ⌀8,5 ⇄43 ↗30 mm

Per commutazione e regolazione dell'intensità e comando degli effetti luminosi delle Strips MaxLED RGBW (nessun contatto visibile necessario, portata fino a 30 m all'aperto).

Sensori per tutte le Strips MaxLED

Sensori nel formato piccolo per Strips LED monocromatiche – perfetti per profili



Night PIR Sensor **79841**

max. 144 W, DC 24 V
⌀16 ⇄56,5 ⌀12,5 mm

Rilevatore di movimento per il controllo senza contatto dipendente dalla luce.

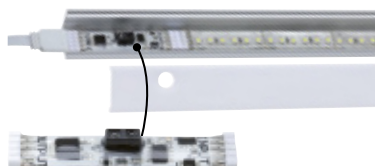

Touchless Sensor **79840**

max. 144 W, DC 24 V
⌀7 ⇄56,5 ⌀12,5 mm

Interruttore di prossimità (<5 cm) per il controllo senza contatto. Dimmerabile.

Sensori wireless MaxLED

Il design incontra la funzionalità:
Comando senza fili per Strips LED

- Sensori senza fili per il comando delle Strips MaxLED Single Color con la massima comodità
- Il design minimale e di alta qualità valorizza l'installazione luminosa
- Set con controller e sensori singoli come estensione
- Due versioni: con interruttore touch on/off e funzione dimming oppure con il rilevatore di movimento Night PIR aggiuntivo
- A ogni controller è possibile abbinare 10 sensori
- Abbinamento semplice dei sensori tramite il pulsante Match Pairing
- Con supporto magnetico – per il fissaggio alla parete o come base flessibile per configurazioni personalizzate
- Supporto con nastro adesivo 3M di alta qualità applicato posteriormente per il montaggio a parete
- Valori di portata: dal sensore al ricevitore 6 m, area di reazione Night PIR Sensor 3 m
- Eccezionale efficienza – batteria (CR 2450) con durata fino a 1 anno o 7000 attivazioni

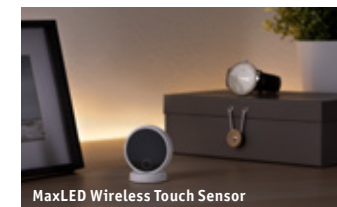

Articoli con Night PIR Sensor:

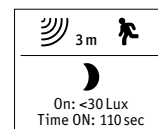

On: <30 Lux
Time ON: 110 sec



MaxLED Wireless Touch Sensor Set **71225**

max. 144 W, DC 24 V
⌀53,8 ⇄48,3 ⌀36,6 ø 48,3 mm



MaxLED Wireless Touch + Night PIR Sensor Set **71226**

max. 144 W, DC 24 V
⌀53,8 ⇄48,3 ⌀36,6 ø 48,3 mm



MaxLED Wireless Touch Sensor **71227**

⌀53,8 ⇄48,3 ⌀36,6 ø 48,3 mm



MaxLED Wireless Touch + Night PIR Sensor **71228**

⌀53,8 ⇄48,3 ⌀36,6 ø 48,3 mm

Realizza i tuoi progetti di illuminazione

Progetto esemplificativo 1: Parete TV illuminata

con MaxLED 250 RGBW

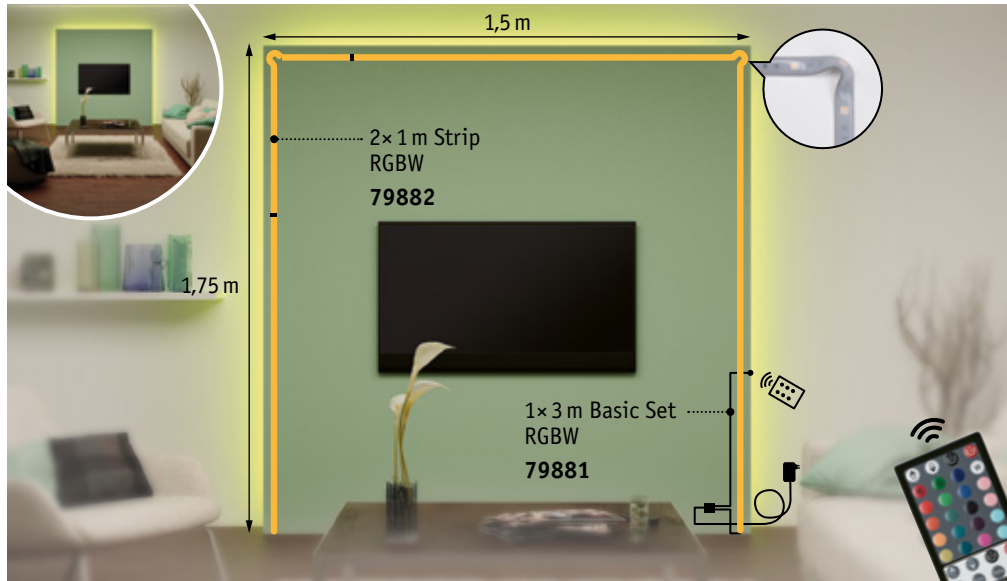

Progetto esemplificativo 3: Luce di lavoro nell'home office

con MaxLED 500 Tunable White



Progetto esemplificativo 2: Illuminazione delle scale per maggiore sicurezza

con MaxLED 250 Warm White



Progetto esemplificativo 4: Illuminazione per gli spazi abitativi

con MaxLED 1000 Warm White

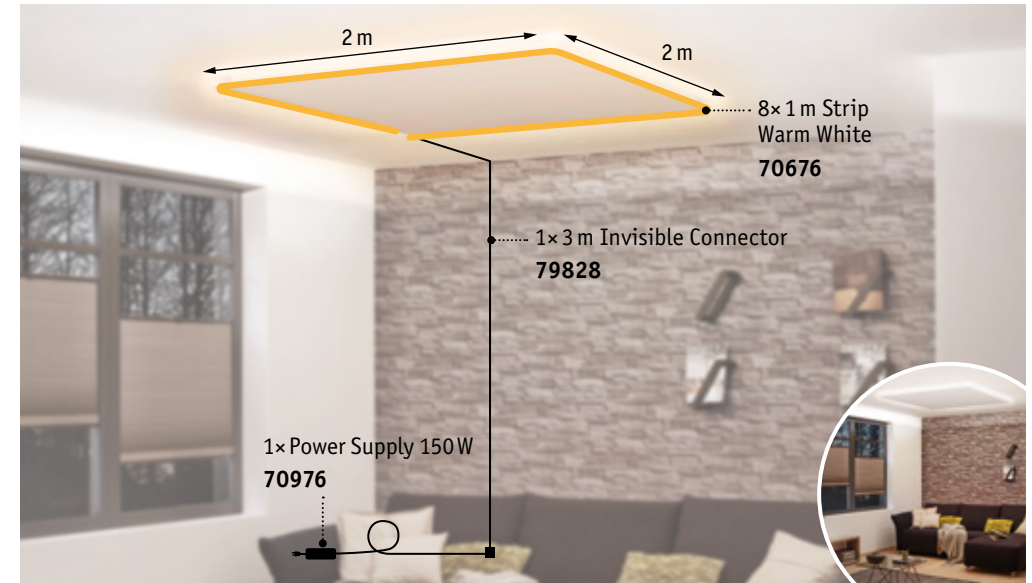

I profili in sintesi

Sviluppati appositamente per le Strips Paulmann



Profili per il montaggio

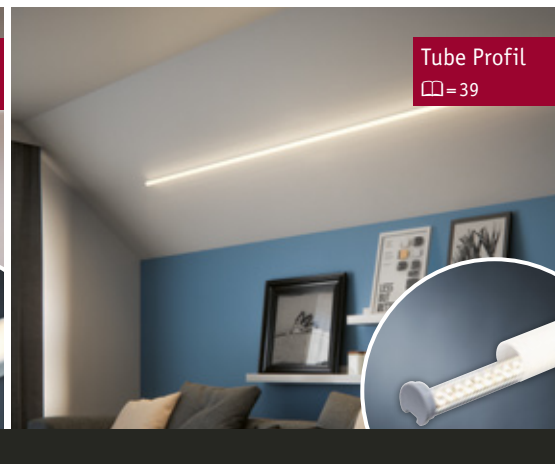
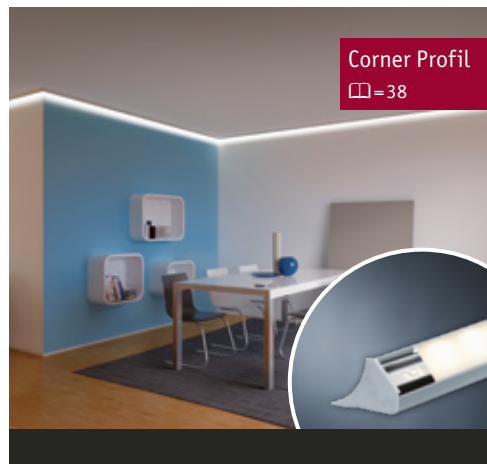

Profilo da incasso

Qui trovi maggiori informazioni sui nostri profili:



www.paulmann.com/elegant-LED-profiles



Base Profil

Profilo per il montaggio in alluminio discreto

- Perfetto per pareti o mobili
- Disponibile in cromo opaco o nero di tendenza
- I profili sono accorciabili in modo personalizzato e comprendono tutte le Strips LED dell'assortimento Paulmann

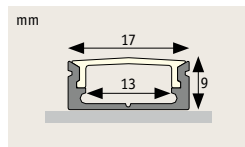

Base Profil incl. diffusore



Base Profil 1 m **70517**
 $\varnothing 9 \leftrightarrow 1000 \varnothing 17$ mm

Base Profil 2 m **70518**
 $\varnothing 9 \leftrightarrow 2000 \varnothing 17$ mm



Base Profil 1 m **78902**
 $\varnothing 9 \leftrightarrow 1000 \varnothing 17$ mm

Base Profil 2 m **78901**
 $\varnothing 9 \leftrightarrow 2000 \varnothing 17$ mm



Square Profil

Profilo per il montaggio per Strips LED

- Le pratiche clip di supporto incluse nella fornitura consentono il montaggio in piano o inclinate a parete e soffitto
- Disponibile in cromo opaco o nero di tendenza
- I profili sono accorciabili in modo personalizzato e comprendono tutte le Strips LED dell'assortimento Paulmann

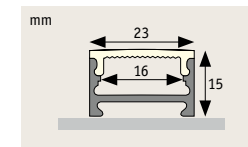

Square Profil incl. diffusore



Square Profil 1 m **70809**
 $\varnothing 15 \leftrightarrow 1000 \varnothing 23$ mm

Square Profil 2 m **70810**
 $\varnothing 15 \leftrightarrow 2000 \varnothing 23$ mm



Square Profil 1 m **78904**
 $\varnothing 15 \leftrightarrow 1000 \varnothing 23$ mm

Square Profil 2 m **78903**
 $\varnothing 15 \leftrightarrow 2000 \varnothing 23$ mm



iF Product Design Award

Il Delta Profil di Paulmann è stato insignito dell'iF product design award da esperti di design provenienti da tutto il mondo. Con questo marchio di qualità riconosciuto in tutto il mondo la giuria internazionale ha premiato prodotti d'eccellenza nel campo del design.

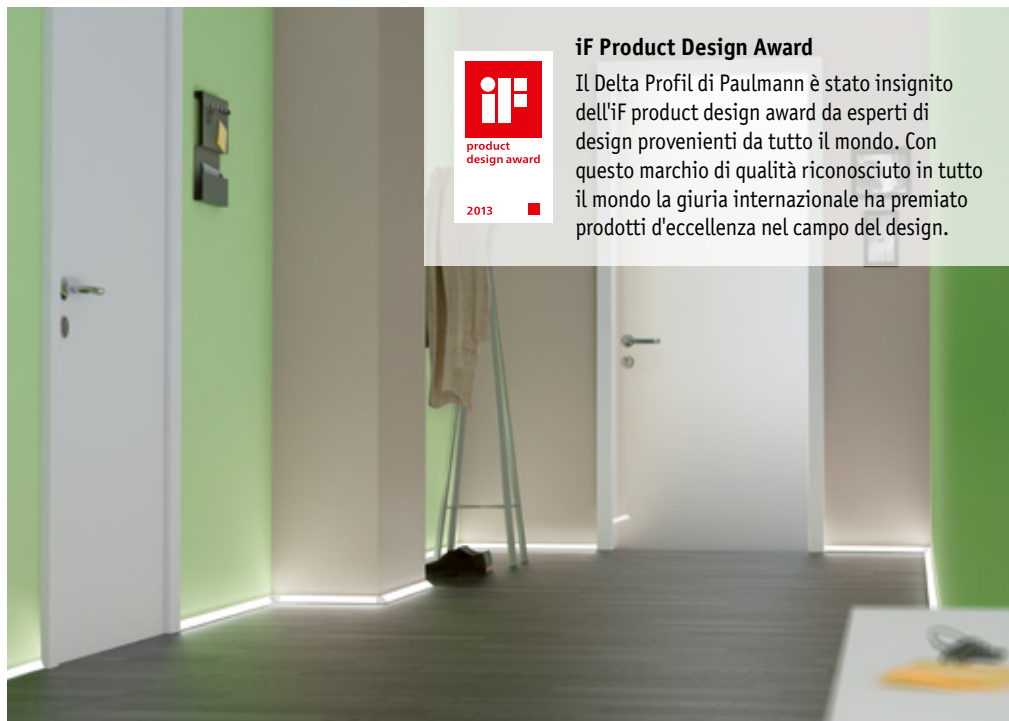

Delta Profil

Innovazioni per un'illuminazione d'interni decorativa

Battiscopa illuminati in primo piano

- Profili triangolari per illuminare battiscopa, bordi di chiusura, sottopensili e molto altro ancora
- Pregiato profilo in alluminio resistente a urti e graffi grazie al rivestimento in alluminio anodizzato
- I profili sono accorciabili in modo personalizzato e comprendono tutte le Strips LED dell'assortimento Paulmann

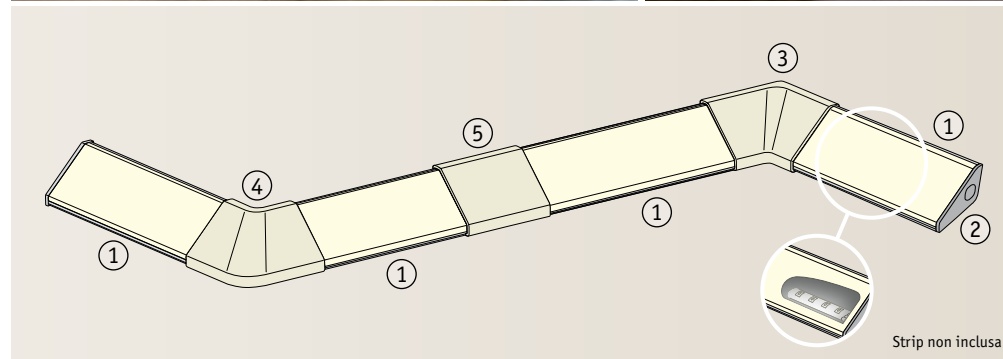
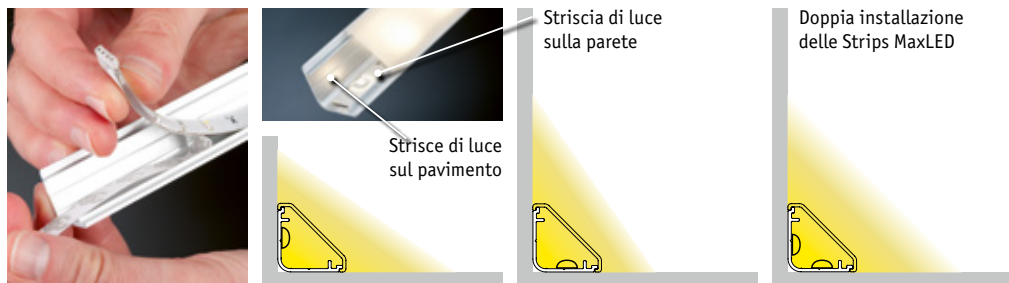
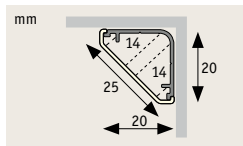

① Delta Profil con diffusore



Delta Profil 1 m **70262**
 ⌀20 ⇄1000 ⌀20mm

Delta Profil 2 m **70261**
 ⌀20 ⇄2000 ⌀20mm

② Elemento di chiusura



End Cap **70266**
 ⌀20 ⇄8 ⌀20mm

③ Angolo interno



Inside Corner **70264**
 ⌀21 ⇄35 ⌀35mm

④ Angolo esterno



Outside Corner **70265**
 ⌀21 ⇄35 ⌀35mm

⑤ Coperchio di chiusura



Cover **70263**
 ⌀29 ⇄35 ⌀5mm



Duo Profil

Pareti e soffitti: ripartizione degli spazi di grande effetto

Arricchisci i tuoi spazi abitativi di accenti luminosi per una nuova avvolgente atmosfera.

- Disponibili come componenti singoli o inclusi in un pratico set
- Un pregiato rivestimento in alluminio anodizzato protegge i vostri profili in alluminio conferendo loro allo stesso tempo una delicata brillantezza
- Il diffusore opzionale presenta la luce in modo uniforme
- I profili sono accorciabili in modo personalizzato e comprendono tutte le Strips LED dell'assortimento Paulmann

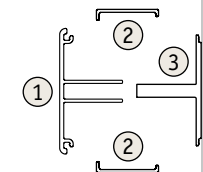
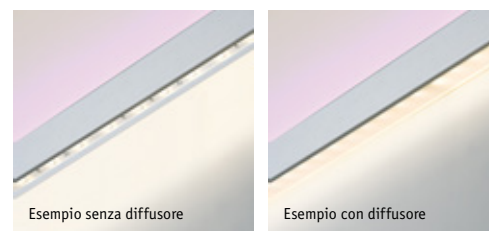
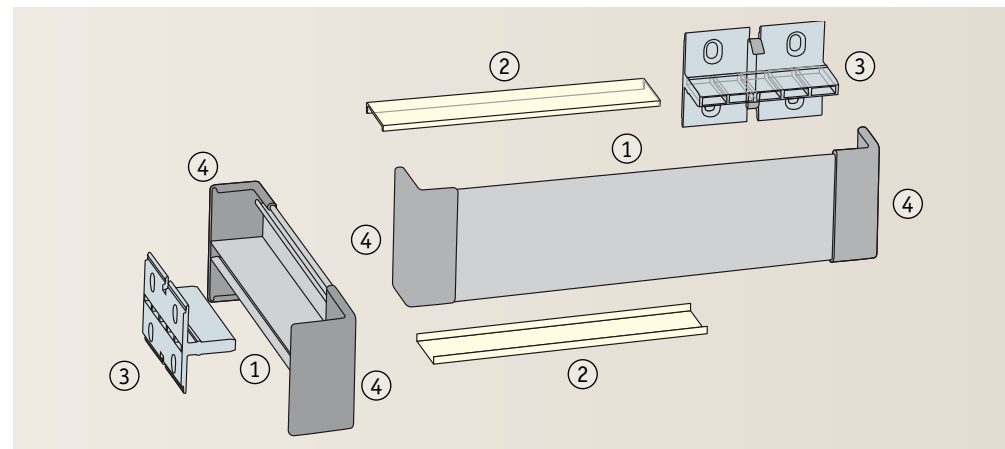
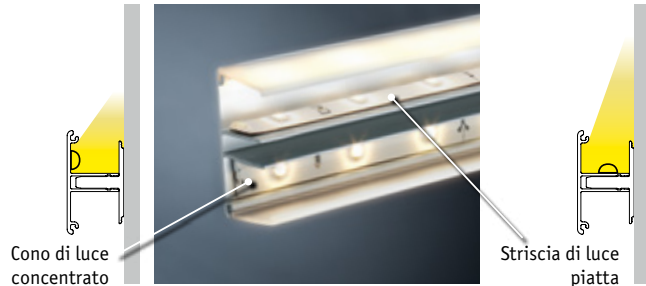
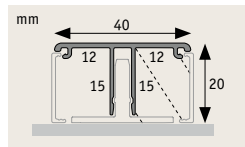

① + ② + ③ Starter Set Duo Profil



Duo Profil Set 1 m 70520
 ⌀40 ⇄1000 ⌀20 mm
 (include 1x profilo, 1x diffusore e 2x Fixture)

Duo Profil Set 2 m 70519
 ⌀40 ⇄2000 ⌀20 mm
 (include 1x profilo, 1x diffusore e 3x Fixture)

② per un'illuminazione omogenea



Diffusor 2 m 70269
 ⌀4 ⇄2000 ⌀20 mm

③ Supporto per montaggio a parete



Fixture 70275
 ⌀36 ⇄50 ⌀21 mm

④ Elemento di chiusura



End Cap 70274
 ⌀42 ⇄22 ⌀24 mm

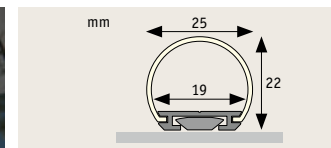
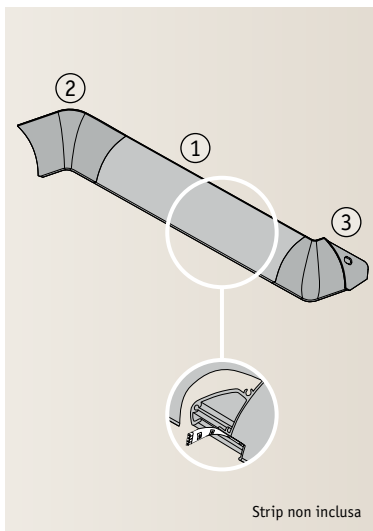

Tube Profil

Profilo per il montaggio rotondo di grande effetto

- Affascinante emissione della luce con un angolo di diffusione di 180°
- Effetto coinvolgente nella combinazione con Strips MaxLED RGBW colorate
- Ideali come plafoniere o appliques



Tube Profil 2 m **70560**

∅22 ⇄2000 ∇25 mm

Corner Profil

Illuminazione indiretta ed elegante per soffitti

Il profilo farà fluttuare i soffitti dei tuoi ambienti

- Con il profilo per soffitto decorativo illumini indirettamente le tue pareti
- Il profilo è sopraverniciabile e tappezzabile
- Fissaggio con adesivi da costruzione comunemente in commercio
- I profili sono accorciabili in modo personalizzato e comprendono tutte le Strips LED dell'assortimento Paulmann

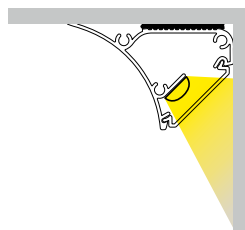
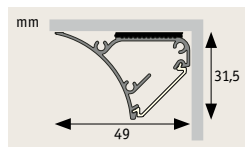

① Corner Profil incl. diffusore



Corner Profil 1 m **70440**

∅31,5 ⇄1000 ∇49mm

Corner Profil 2 m **70439**

∅31,5 ⇄2000 ∇49mm

② Angolo esterno

③ Angolo interno



Outside Edge **70441**

∅31,5 ⇄49 ∇49 mm



Inside Edge **70442**

∅31,5 ⇄59 ∇59 mm

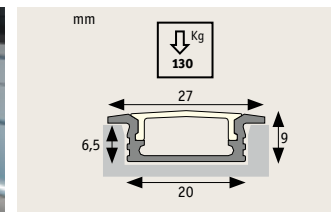

Floor Profil

Profilo da incasso per pavimenti o pareti

- Profilo da incasso per creare accenti luminosi su pavimento, mobili o altri materiali solidi
- I profili sono accorciabili in modo personalizzato e comprendono tutte le Strips LED dell'assortimento Paulmann

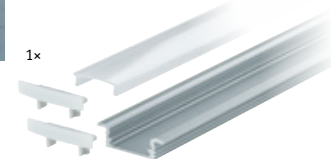

Floor Profil 1 m **70410**

∅9 ⇄1010 ∇27mm

Floor Profil 2 m **70409**

∅9 ⇄2010 ∇27mm

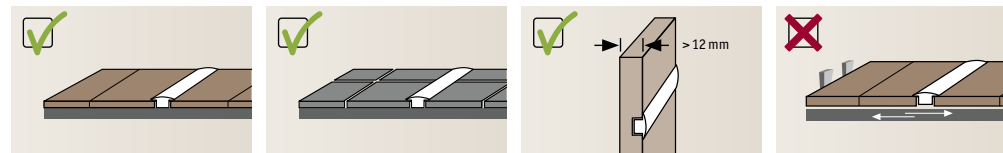

5 Jahre Year Ans
Jaar Años Annos
Garantie

www.paulmann.com/guarantee

25/006 I 505 110 101



Ulteriori fonti d'ispirazione per:



Strips MaxLED



Profili eleganti

www.youtube.com/PaulmannLicht



www.paulmann.com

Paulmann Licht GmbH | Quezinger Feld 2 | 31832 Springe/Germany