

Safety Instructions

1, 2, 3, 4, 5, 6, 10, 11, 13, 19,
22, 23, 24, 25, 26, 33, 34



Info

www.paulmann.com

Paulmann Licht GmbH
Quezinger Feld 2
31832 Springe
Germany

www.paulmann.com

Art.-Nr.: 988.48



988.48

(+MA 326) PAW 08/22

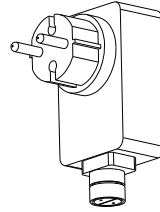

1x

A

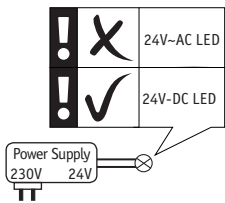
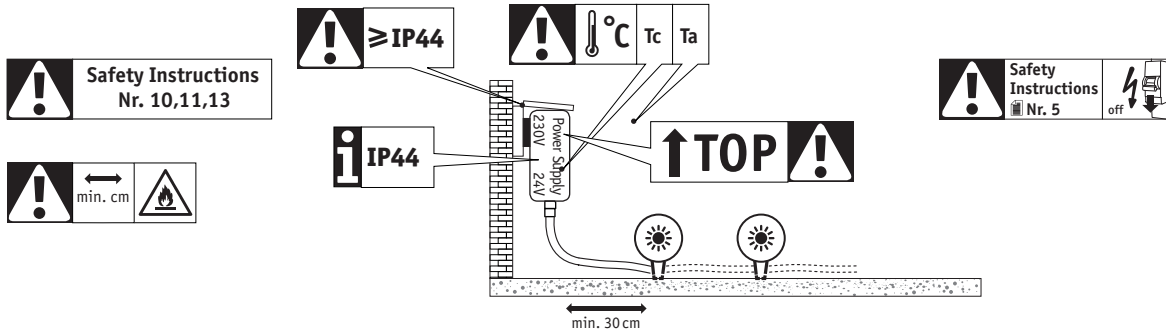

Nr. 11

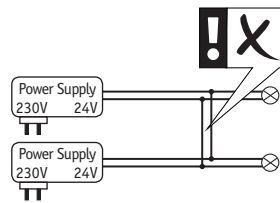

Power Supply 21W
Art.-Nr.: 988.48

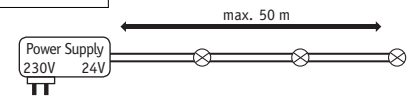

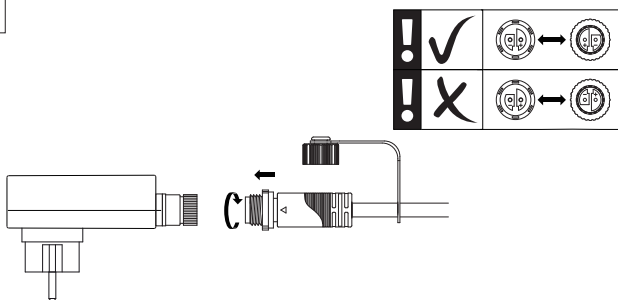

B1 B2

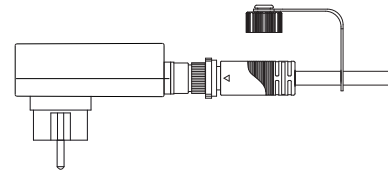

B1 B2

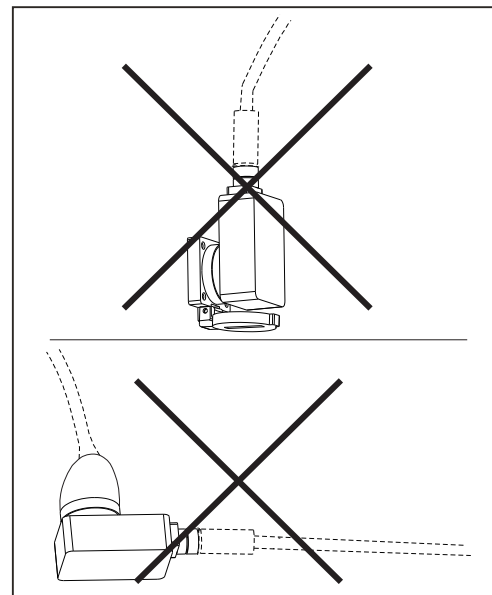
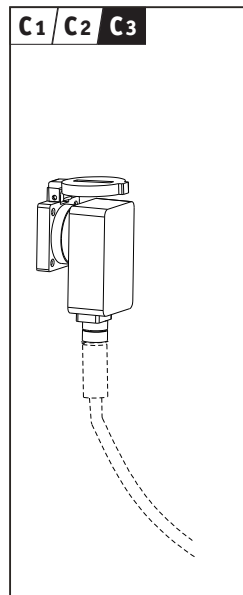
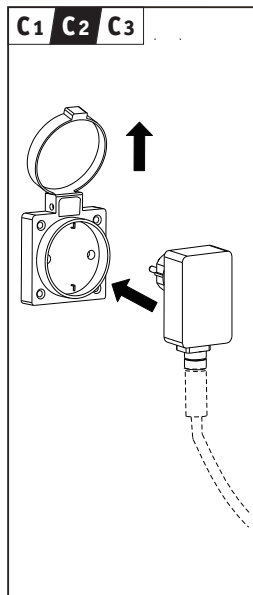
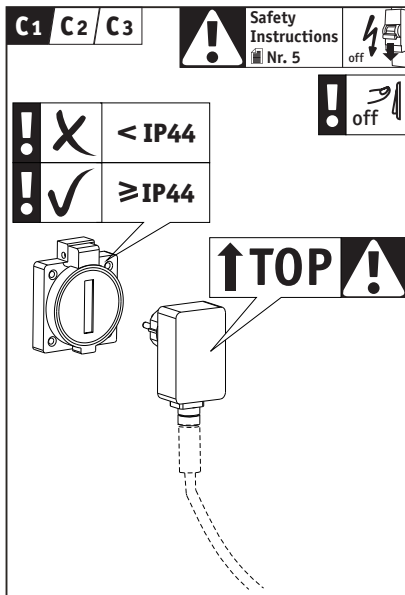



 = D Altgeräte dürfen nicht in den Restmüll. Sie können bei öffentlichen Sammelstellen von Entsorgungsträgern abgegeben werden. Altbatterien und Altakkumulatoren, sowie Lampen, die zerstörungsfrei aus dem Altgerät entnommen werden können, sind vor der Abgabe an eine Erfassungsstelle von dem Altgerät zu trennen. Vertreiber sind im Rahmen von § 17 Absatz 1 und 2 ElektroG zur unentgeltlichen Rücknahme dieses Produktes verpflichtet. Endnutzer von Altgeräten müssen eigenverantwortlich für die Löschung personenbezogener Daten auf den zu entsorgenden Altgeräten sorgen.

www.paulmann.com



Paulmann

Safety Instructions

1, 2, 3, 4, 5, 6, 7, 8, 9, 10, 11, 12



Info

www.paulmann.com

Paulmann Licht GmbH
Quezinger Feld 2
31832 Springe
Germany

www.paulmann.com

Art.-Nr.: 939.26

939.27

939.28

939.29

939.30

939.31

939.94

(+MA 327) PH03/17



 939.94

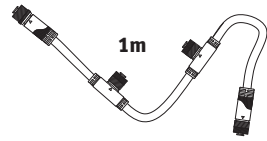

1m

1x

 939.26

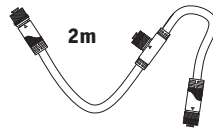

2m

1x

 939.27

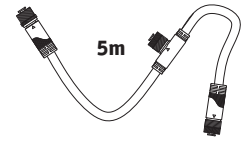

5m

1x

 939.28

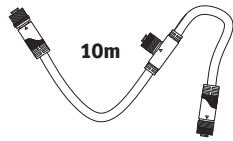

10m

1x

 939.30

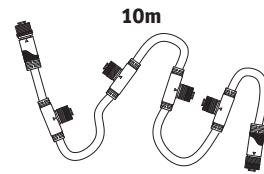

10m

1x

 939.31

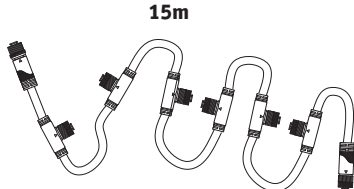

15m

1x

 939.29

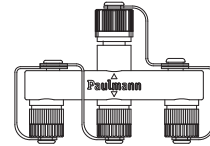

1x

A1 A2 A3

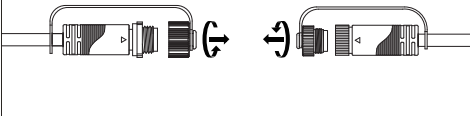
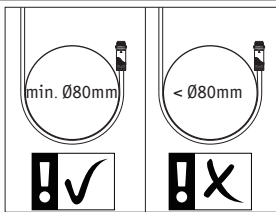

A1 A2 A3

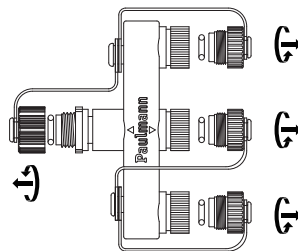

A1 A2 A3



B1 B2 B3

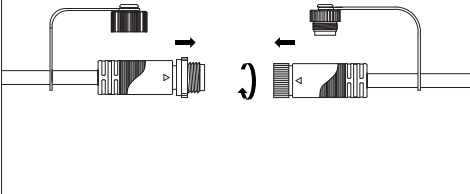
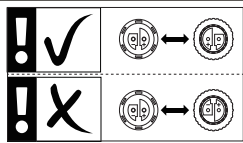

B1 B2 B3

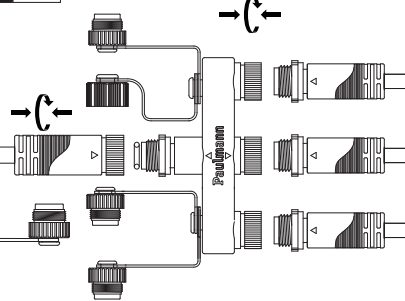

B1 B2 B3

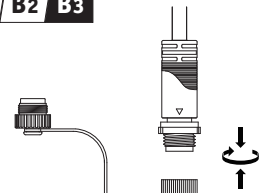

C1 C2 C3

max. 50m
max. 150W

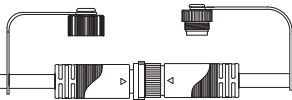

C1 C2 C3

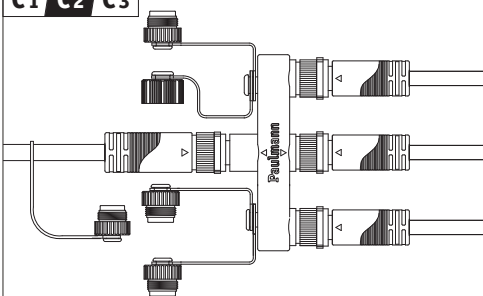

C1 C2 C3

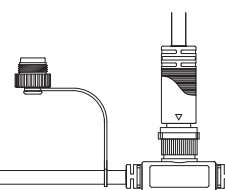



Paulmann

Safety Instructions

IP67

31.08.2021 01.09.2021

ENERGY LABEL 874/2012 A++ - A

ENERGY LABEL 2019/2015 E F G

941.85 941.78 941.75
941.79 941.76
941.81 941.77
941.82 941.80
941.83 941.84

www.paulmann.com/symbols

Paulmann Licht GmbH
Quezinger Feld 2
31832 Springe
Germany

www.paulmann.com

Art.-Nr.: 941.75
941.76
941.77
941.78
941.79
941.80
941.81
941.82
941.83
941.84
941.85

PH07/22

941.75
941.76

1x

1x

941.77
941.78
941.79

1x

1x

941.80
941.81
941.82

1x

1x

941.83

1x

1x

941.84

1x

1x

941.85

1x

1x

A

min. Ø72mm

< Ø72mm

B

C

max. 50m
max. 150W

D

E

Driver
Paulmann
Art.-Nr. 988.48

Control Box

Remote Control

not incl.

Paulmann
Art.-Nr. 180.11

