



Paulmann

Safety Instructions

1, 2, 3, 4, 5, 6, 7, 8, 9, 13, 14, 16, 19, 22, 24, 28, 33, 34



Info

www.paulmann.com

Paulmann Licht GmbH
Quezinger Feld 2
31832 Springe
Germany

www.paulmann.com

Art.-Nr.: 500.43

(+MA 326) PAW08/22



1x

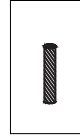

incl.



A



Safety Instructions
Nr. 1, 2, 4

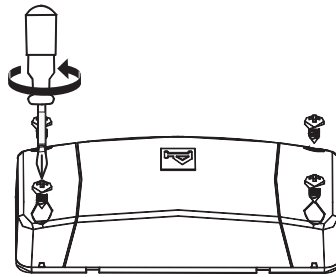

B

INPUT:

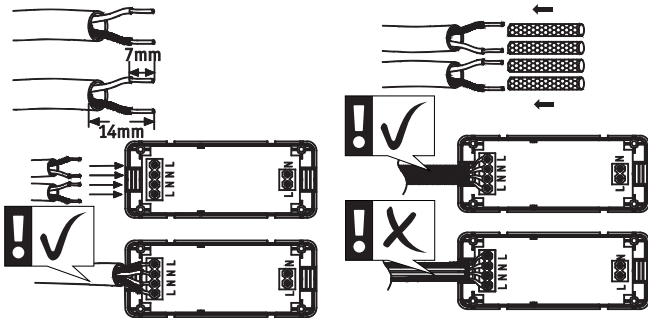

OUTPUT:

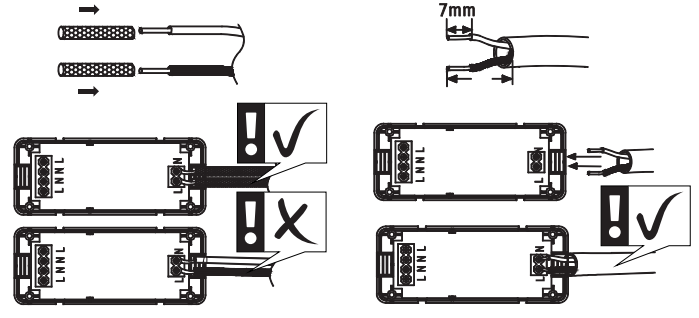

Safety Instructions
Nr. 4, 5, 6

C

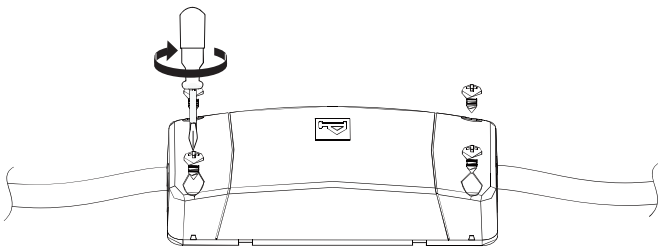

D

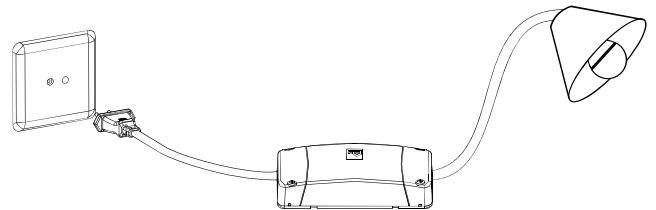

E

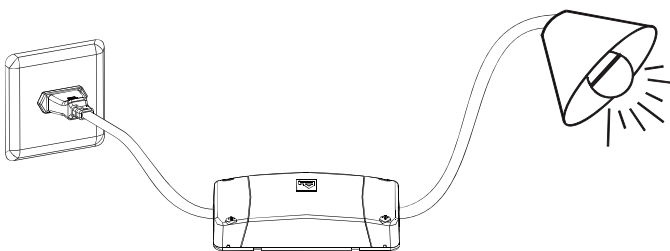

on

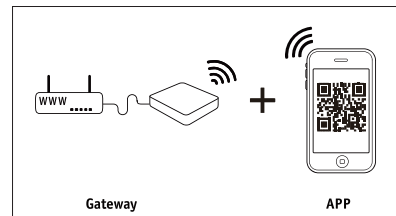

Gateway

APP

or



Remote Control

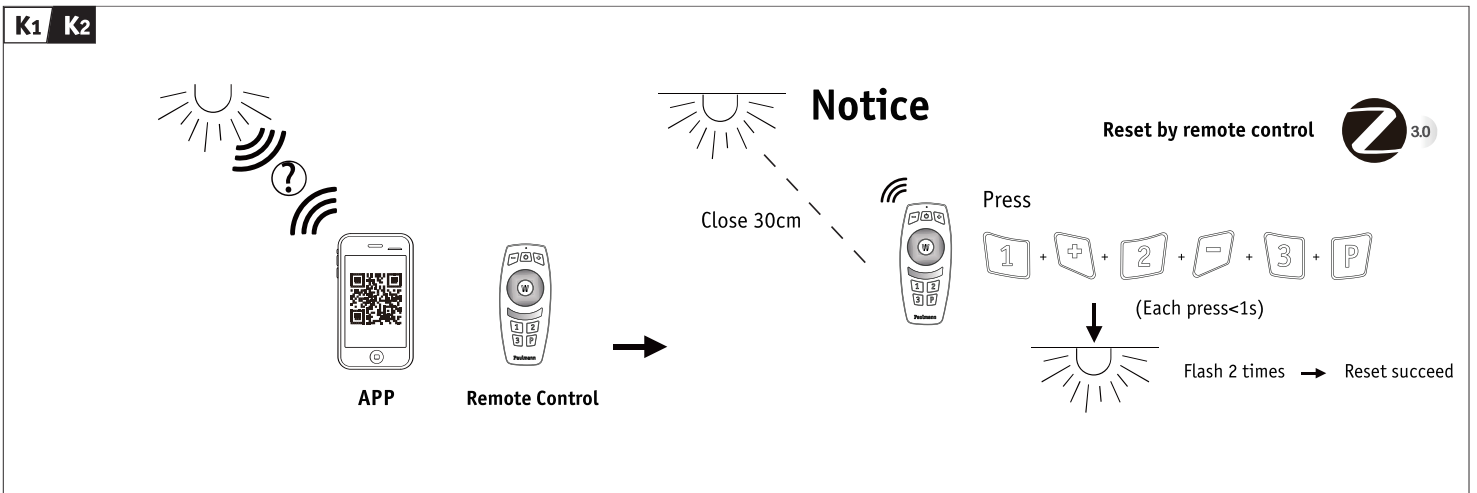
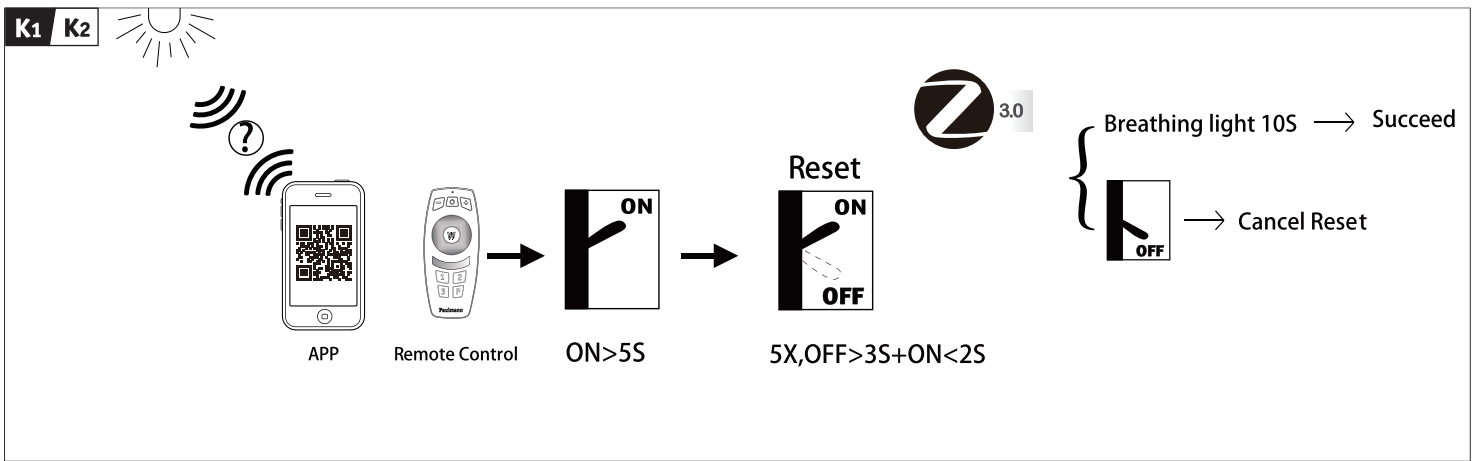

Zugelassen für den Betrieb in allen Ländern der EU / Approved for operating in all European countries
 CE: Konform mit / in accordance with / conformance a 2014/30/EU,
 2014/53/EU <http://www.paulmann.com/de/de/b2b-haendler-log-in.html>
 2,4 GHz - 2,4835 GHz



Doesn't apply for the geographical area within a radius of 20km from the centre on "Ny Alesund"

Hiermit erklärt Paulmann Licht, dass der Funkanlagentyp Art.-Nr.: 500.43 der Richtlinie 2014/53/EU entspricht. Der vollständige Text der EU-Konformitätserklärung ist unter der folgenden Internetadresse verfügbar: www.paulmann.com/ce
 Funk-Frequenz :2.4GHz -2.4835GHz
 Abgestrahlte Energie :10mW



Art.-Nr.: 934.46/47
934.48/49
934.52/53
934.54/50
934.51/55
934.56
944.71

i IP23

934.46/934.48

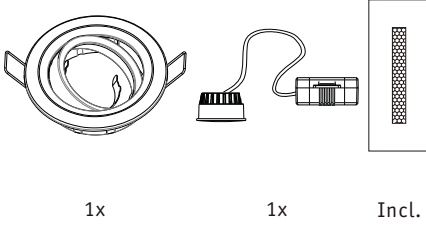

934.47/934.49/934.52/944.71

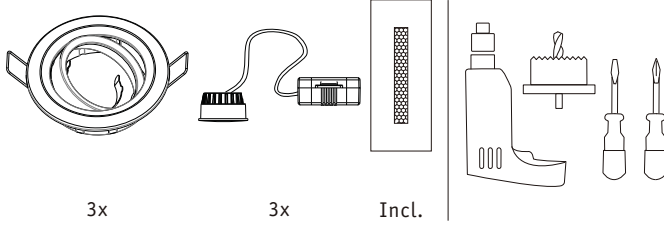

(+MA326) PSU 07/22
CE UK CA

i IP23

934.53

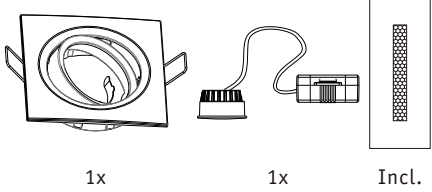

934.54

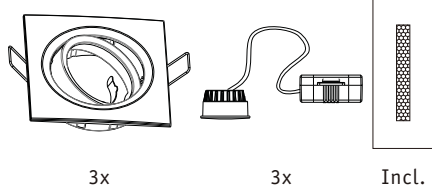

934.50

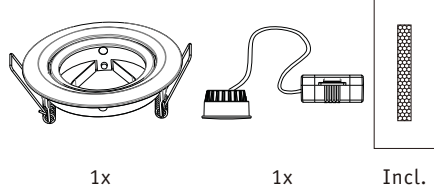

i IP23

934.51

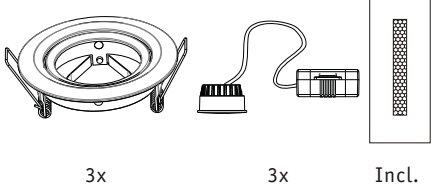

934.55

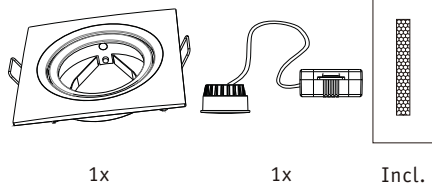

934.56

