

Safety Instructions

1, 2, 3, 4, 5, 6, 7, 8, 11, 12, 15,
16, 17, 18, 19, 20, 21, 22, 24,
26, 28, 29, 30, 31, 32, 33, 34



Info Hotline



+49 (0) 5041 998 389

Mon. - Do. 7⁰⁰ - 20⁰⁰
Fr. 7⁰⁰ - 17⁰⁰

Paulmann Licht GmbH
Quezinger Feld 2
31832 Springe
Germany

www.paulmann.com

Art.-Nr.: **954.39**
954.41
(+MA326) PSU 07/16



1x

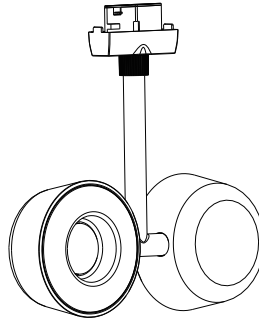

A

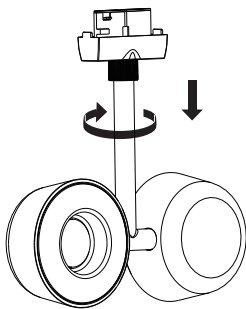

Safety Instructions
Nr. 1, 4, 5

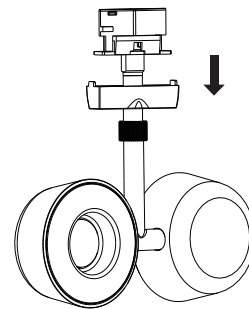

B

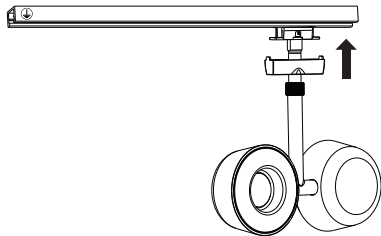

Nr. 3, 4, 5, 6

C

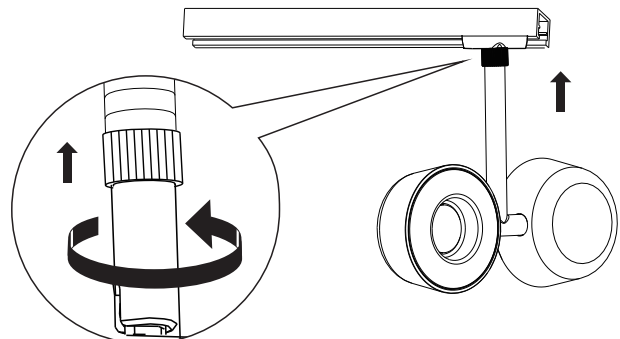

D

