

**Safety Instructions**

1, 2, 3, 4, 5, 6, 7, 9, 11, 12, 13, 14, 15, 16, 17, 18, 19, 21, 22, 23, 25, 28, 30, 31, 34



**Info Hotline**



**+49 (0) 5041 998 389**  
 Mon.-Do. 7<sup>00</sup>-20<sup>00</sup>  
 Fr. 7<sup>00</sup>-17<sup>00</sup>

Paulmann Licht GmbH  
 Quezinger Feld. 2  
 31832 Springe  
 Germany

www.paulmann.com

Art.-Nr.: 977.53  
 977.54

(+MA 197) PDG 10/16

**CE**

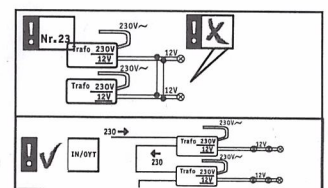
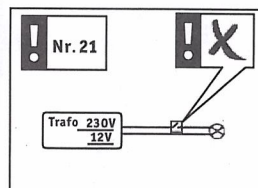
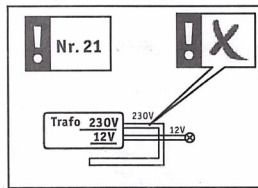
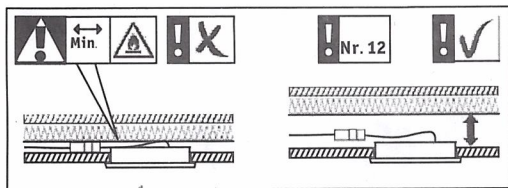
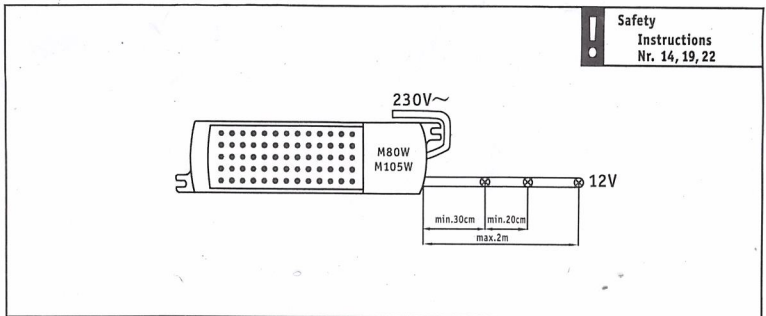
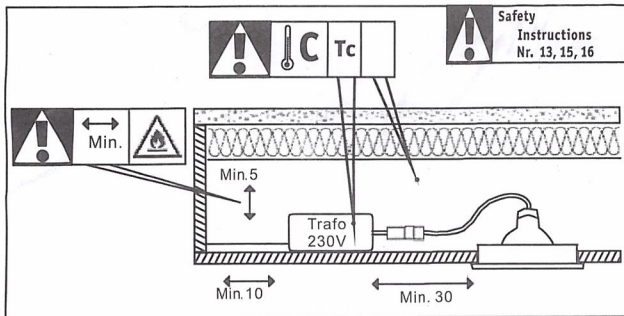
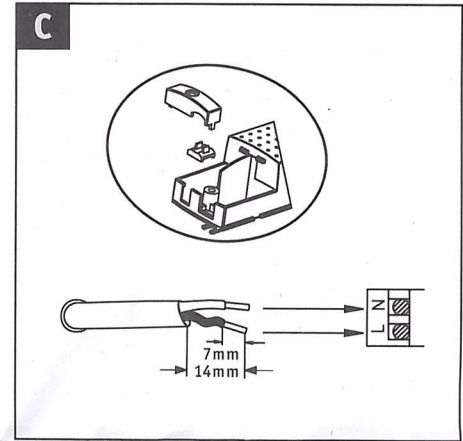
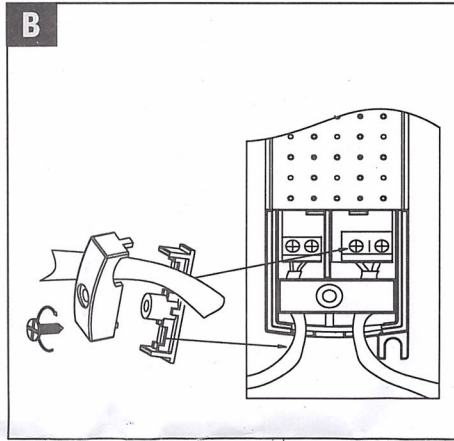
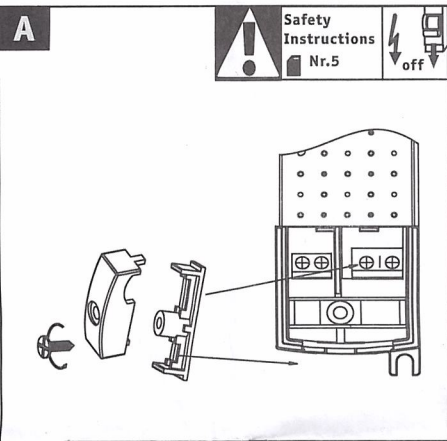

<p><b>Trafo 80/105VA</b>                  Art.-Nr.: 977.53 977.54</p>	<p><b>Safety Instructions</b>                  Nr. 28a/b</p>	<p><b>R, L, C</b></p>	<p><b>80VATC: +75°C</b>  <b>105VATC: +80°C</b></p>	<p><b>Ta</b>                  - 20 +50°C</p>	
<p><b>12V</b>  <b>230V</b></p>	<p><b>230V PRI</b></p>	<p>14mm                  7mm</p>	<p>✓ H03VVH2-F                  ✓ H05VVH2-F                  ✓ NYM3 × 2.5mm<sup>2</sup></p>	<p>2 × 0.75mm<sup>2</sup></p>	<p>min. 2x0,75mm<sup>2</sup></p>
	<p><b>12V SEC</b></p>	<p>14mm                  7mm</p>	<p>min. H03VVH2-F 1.0mm<sup>2</sup>X2</p>	<p>min. 2x0,75mm<sup>2</sup></p>	<p>min. 2x0,75mm<sup>2</sup></p>